

Remote Keypad Instruction Manual

RKP002Z

NOTICE

1. Make sure that this instruction manual is delivered to the end user of Remote Keypad.
2. Read this manual before installing or operating the Remote Keypad. Keep it in a safe place for reference.
3. All information contained in this manual are subject to change without notice. Please confirm the latest information on our web site "www.inverter.co.jp".





Safety precautions

On the inverter and in its instruction manual, important information is contained for preventing injuries to users, damages to assets, and for proper use of the device.

Read the instruction manual attached to the inverter along with this instruction manual to completely understand the safety precautions, the symbols and indications shown below. Please adhere to the contents of these manuals at all times.





Explanation of markings

Marking	Meaning of marking
 Danger	Indicates that errors in operation may lead to death or serious injury.
 Warning	Indicates that errors in operation may lead to injury (*1) to people or that these errors may cause damage to physical property. (*2)

(*1) Such things as injury, burns or shock that will not require hospitalization or long periods of outpatient treatment.

(*2) Physical property damage refers to wide-ranging damage to assets and materials.





Meanings of symbols

Marking	Meaning of marking
	Indicates prohibition (Do not do it). What is prohibited will be described in or near the symbol in either text or picture form.
	Indicates something mandatory (must be done). What is mandatory will be described in or near the symbol in either text or picture form.
	Indicates danger. What is dangerous will be described in or near the symbol in either text or picture form.
	Indicates warning. What the warning should be applied to will be described in or near the symbol in either text or picture form.





■ Limitation of use

 Safety precaution	
▼	Never use this unit with any device other than TOSVERT series inverters. Doing so may cause an accident.



■ Handling in general

 Danger	
 Never Disassemble	<ul style="list-style-type: none"> ▼ Never disassemble, modify or repair the product. Disassembling the product may cause electric shocks, fire or injuries. For repairs, call your sales/repair agency.
 Prohibited	<ul style="list-style-type: none"> ▼ Do not put or insert foreign objects such as waste cable, bars, or wires into the product. It may lead to electric shocks or fire. ▼ Do not splash water over the product, and do not wipe the body with a wet cloth. It may lead to electric shocks or fire.
 Mandatory	<ul style="list-style-type: none"> ▼ Turn off input power before wiring. Wait at least 15 minutes and check to make sure that the charge lamp (on the inverter unit) is no longer lit. ▼ Turn off the power immediately in case of any abnormalities such as smoke, smell or abnormal noise. Neglect of these conditions may lead to fire. For repairs, call your sales/repair agency.

■ Transportation and installation

 Danger	
 Prohibited	<ul style="list-style-type: none"> ▼ Do not install or operate the inverter if it is damaged or any part of it is missing. Operating a defective inverter may lead to electric shocks or fire. For repairs, call your sales/repair agency. ▼ Do not put any flammable material near the product. It may catch fire due to the product sparking in the case of a malfunction. ▼ Do not connect a LAN cable or telephone modular cable to Remote Keypad. Doing so may cause a failure or accident.
 Mandatory	<ul style="list-style-type: none"> ▼ Electrical construction work must be done by a qualified expert. Connection of input power by someone who does not have expert knowledge may result in fire or electric shock. ▼ Operate under the environmental conditions prescribed in the instruction manual. Operations under any other conditions may result in malfunction. ▼ An emergency stop device must be installed that fits with system specifications (e.g. shut off input power then engage mechanical brake). Operation cannot be stopped immediately by the inverter or Remote Keypad alone, thus risking an accident or injury. ▼ Use the Toshiba-specified cable for connecting this optional unit. (Refer to page 4.) The use of any other option may result in an accident.
 Warning	
 Prohibited	<ul style="list-style-type: none"> ▼ Do not install the product in any place subject to vibrations or it may fall. This may lead to the product falling and causing injury.

■ Operations

⚠ Danger	
 Prohibited	<ul style="list-style-type: none"> ▼ Do not apply a dropping shock or other physical shocks. Otherwise, damage or malfunction will result. ▼ Do not pull on the cable and connector. It may cause damage or error. ▼ Even if this product is deactivated by an unusual event such as tripping, an operating error, power outage, etc. do not bring any regions of your body into contact with the inverter terminals when power is supplied to the inverter. Contact during the power-on status of the inverter can result in electric shock.
 Mandatory	<ul style="list-style-type: none"> ▼ Use an additional safety device with your inverter or system to prevent a serious accident due to the unit malfunctions. Usage without an additional safety device may cause an accident. ▼ Make sure to check that the parameter data from this product is not accidentally copied to the wrong inverter. Usage with wrong parameter may result in an accident.
⚠ Warning	
 Mandatory	<ul style="list-style-type: none"> ▼ Set up “Communication error trip time (<i>F803</i>, <i>F804</i>, see the inverter instruction manual for details)” to stop the inverter when Remote Keypad is deactivated by an unusual event such as tripping, an operating error, power outage, failure, etc. Deactivated Remote Keypad may cause an accident, if the “Communication error trip time” is not properly set up.

■ Disposal

⚠ Warning	
 Mandatory	<ul style="list-style-type: none"> ▼ If you dispose off this unit, have it done by a specialist in industrial waste disposal*. Improper disposal may result in explosion of capacitors or produce noxious gases, resulting in injury. (*) Persons who specialize in the processing of waste and known as “Industrial Waste Product Collectors and Transporters” or “Industrial Waste Disposal Persons.” If the collection, transport and disposal of industrial waste is done by someone who is not licensed for that job, it is a punishable violation of the law (Laws in regard to cleaning and processing of waste materials).

■ Notes on operation

Notes	
	<ul style="list-style-type: none"> ▼ Avoid installing in a place where ambient temperature or/and humidity change sharply. ▼ Keep the transmission cable separate from the power cable of the inverter to prevent the inverter from malfunctioning due to electromagnetic noise. ▼ It is recommended to install the unit on the panel board of a cabinet if it is used as a remote operation panel. Improperly installed units may result in damage and malfunction. ▼ The integrity of data storage is guaranteed for up to 10 years. ▼ The operating life of EEPROM (data storage device) is 10000 operations. Do not execute more than 10000 writing operations. ▼ Do not turn off power or remove the connection cable between the inverter and Remote Keypad while a copying operation is in progress. If the inverter power is turned off or the connection cable is removed while parameters are being copied, data cannot be written correctly. ▼ Do not copy data from Remote Keypad to inverter while the inverter is running. Some of the parameters cannot be written when the inverter is in operation. ▼ When a copying operation is executed between two inverters with different capacities, some of the parameters that vary with the capacity of the inverters will also be copied. Therefore, when copying the parameters between inverters with different capacities or voltage class, the type information parameters of the inverter should always be initialized. See the inverter instruction manual on how to initialize their parameters.

Preface

Thank you for purchasing Remote Keypad (RKP002Z) for TOSVERT series inverters. Using this product, panel operation, display and adjustment of the inverter can be remotely controlled from up to 5 meters away. You can copy data from one place to another and then execute data comparison between the inverter and the memory of Remote Keypad or between the memories of Remote Keypad itself.

Before using Remote Keypad, carefully read this instruction manual in order to completely and correctly utilize Remote Keypad's excellent performance.

After reading this instruction manual, please keep it handy for future reference.

- Part numbering

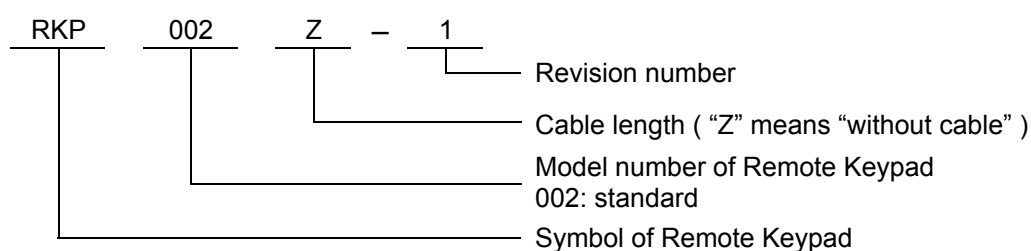

- Accessory check list

Remote Keypad is shipped together with the following accessories.

On opening the packing case, check to see if the following accessories are contained or not.

- (1) Instruction manual 1 copy
(English: E6581277)

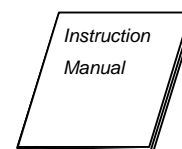

- (2) Mounting screws (M3 x 12mm) 4pcs.
(M3 screw tightening torque: 0.6 N·m)

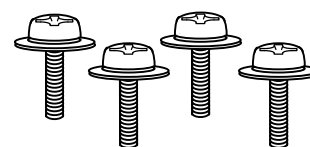

N.B.: Remote Keypad (Part number: RKP002Z) is not provided with connection cable between an inverter and Remote Keypad. This should be purchased separately.

Part number of connection cable between an inverter and an option unit	Cable length
CAB0011	1.2m, 4ft
CAB0013	3.6m, 12ft
CAB0015	4.8m, 16ft

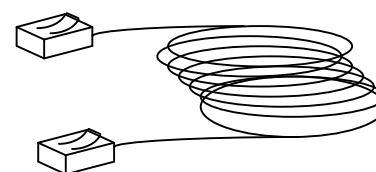

Table of contents

1. Overview	6
2. Names and functions of main parts	7
3. Connection and start-up	8
4. Functions in detail	9
4.1. Procedure to switch the operation mode	9
4.2. "REMOTE KEYPAD MODE"	9
4.3. "COPY MODE"	9
4.3.1. Copying function "COPY"	10
4.3.2. Simple copying function	11
4.3.3. Comparing function "COMP"	12
4.3.4. Memory protection function "PRGT"	13
4.3.5. Memory initializing function "CLR"	14
4.3.6. Remote Keypad parameter editing function	15
5. Before making a service call	16
5.1. Error message	16
5.2. Procedure to reset Remote Keypad	16
5.3. Warning indications	17
5.4. Other problems	17
6. Outline drawing	18
7. Specifications	20
8. Warranty	20

1. Overview

The following seven functions are available with Remote Keypad.

1. Function to serve as remote operation panel.
Remote Keypad can be used as a remote operation panel for the inverter.
2. Copying function
Data can be copied from one memory to another memory among the four memories, three (memories A, B, C) on Remote Keypad and one on the inverter.
 - (i) Data copy from Remote Keypad to inverter
 - (ii) Data copy from inverter to Remote Keypad
 - (iii) Data copy from one memory to another memory on Remote Keypad
3. Simple copying function
Data stored in one of Remote Keypad's memory may be transferred to the inverter's memory by simple operation of two keys.
4. Comparing function
Data stored in one of Remote Keypad's memory can be compared with the data of inverter's memory. In addition, data stored within any of the 3 Remote keypad memories (A, B, or C) can be compared with each other.
5. Memory protecting function
Data written on the inverter's memory and the memories of Remote Keypad are protected by this function to protect against data damage.
6. Memory initializing function
One of the memories (A, B, or C) on Remote Keypad can be initialized by this function. In addition, Remote keypad can be reprogrammed to default setting.
7. Remote Keypad parameter editing function
Remote Keypad parameters are programmable.

■ Memory configuration

Remote Keypad has three memories (A, B, and C) to retain three kinds of parameter for the inverter.

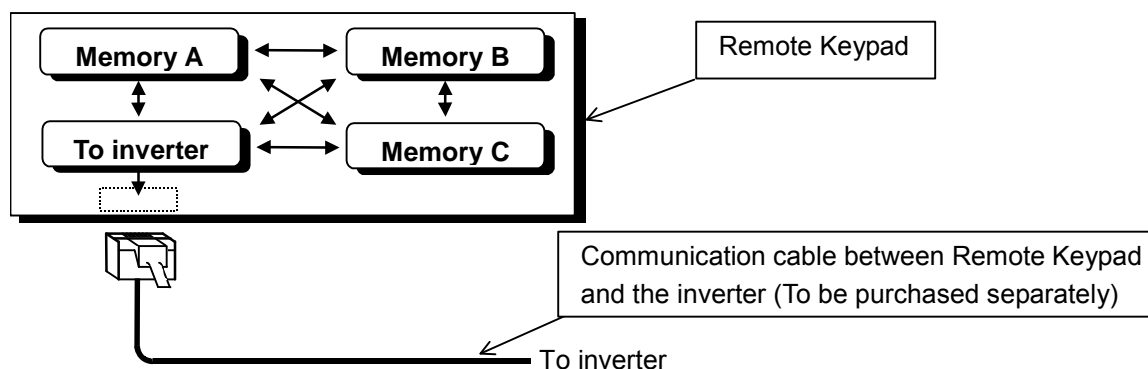

2. Names and functions of main parts

The drawings below show names and functions of main parts.

■ Front view

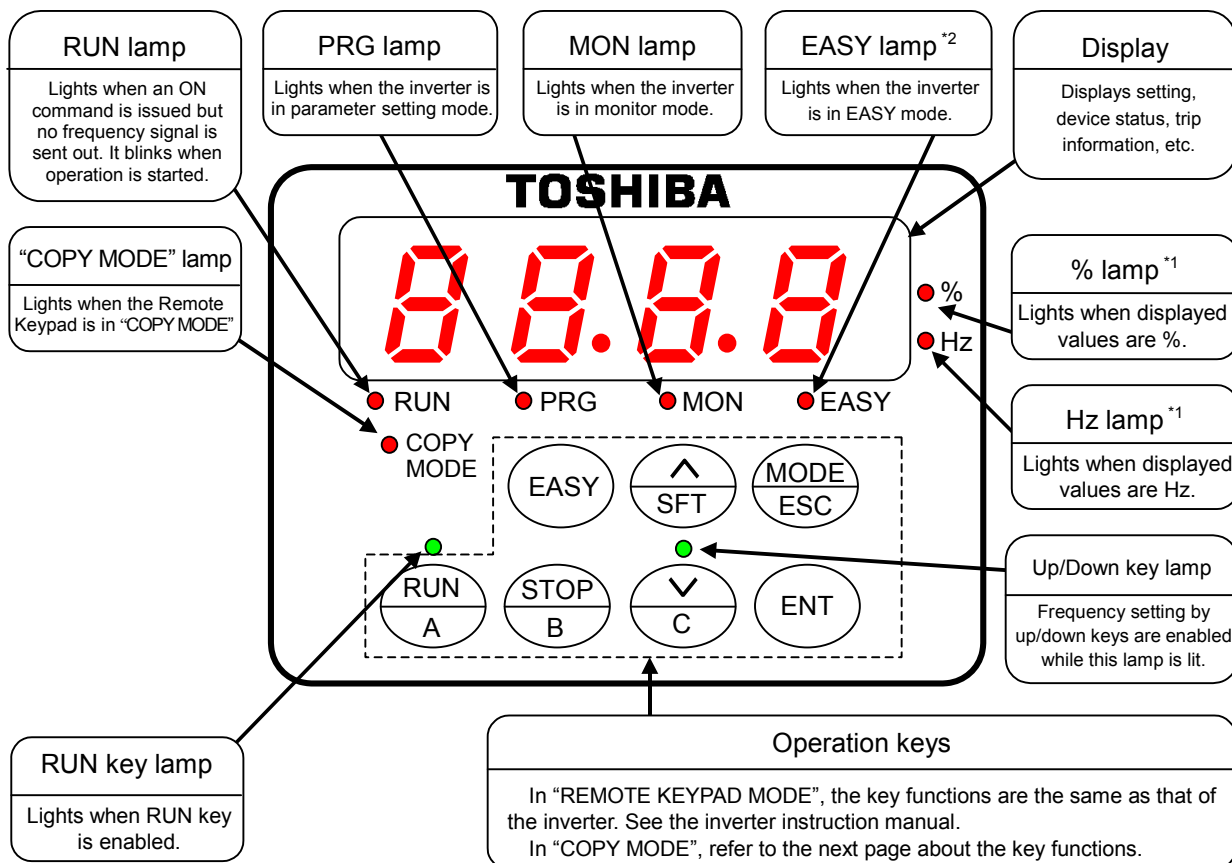

■ Reverse view

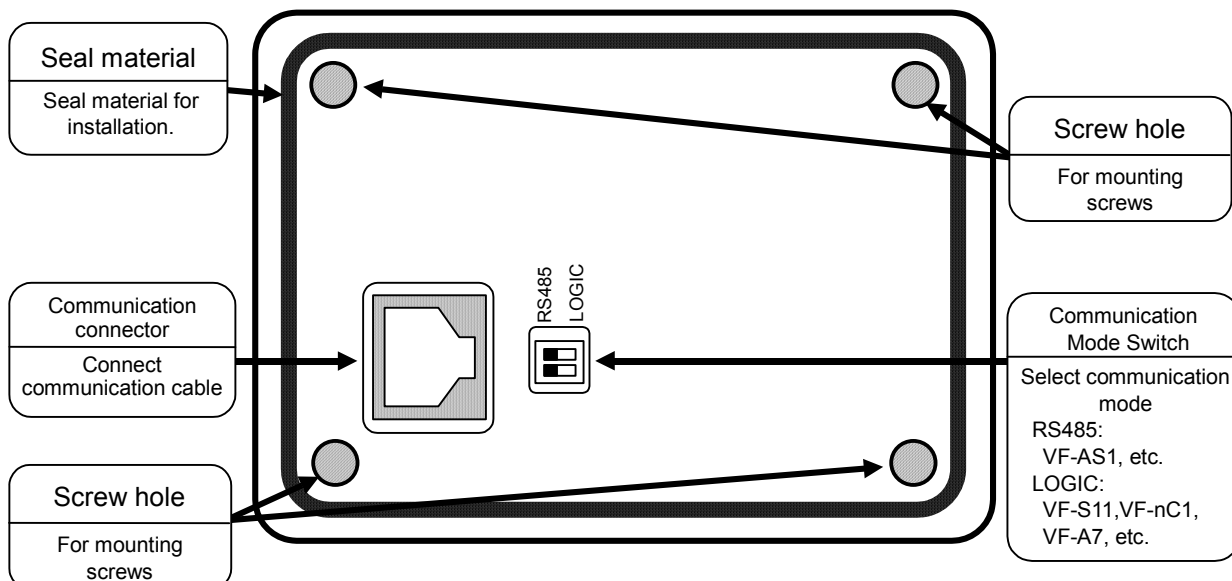



*1: These lamps are not lit when Remote Keypad is connected to VF-S11, VF-nC1, VF-S9, VF-A7, VF-P7 etc.

*2: The lamp is not lit when Remote Keypad is connected to an inverter without [EASY] key.

■ Operation keys and their functions in “COPY MODE”

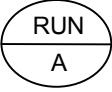
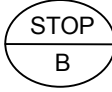
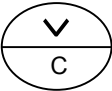
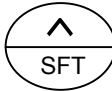
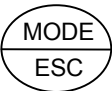
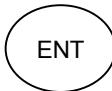
The operation key's functions in “COPY MODE” are explained in the following table.

Operation key	Function	Operation key	Function
	Memory A key (Exclusive key for simple copying) In the simple copying function, this key is used to specify memory A of Remote Keypad as the origin of transmission data. (In “REMOTE KEYPAD MODE”: RUN key)		Memory B key (Exclusive key for simple copying) In the simple copying function, this key is used to specify memory B of Remote Keypad as the origin of transmission data. (In “REMOTE KEYPAD MODE”: STOP key)
	Memory C key (Exclusive key for simple copying) In the simple copying function, this key is used to specify memory C of Remote Keypad as the origin to transmission data. (In “REMOTE KEYPAD MODE”: DOWN key)		SFT key is used for selecting a function (copying, comparing, protecting data) or for selecting a memory from among inverter's memory and memories (A, B, and C) of Remote Keypad. (In “REMOTE KEYPAD MODE”: UP key)
	ESC key is used to return to previous setting (In “REMOTE KEYPAD MODE”: MODE key)		ENT key is used to chose a function or memory or to execute the chosen function. (In “REMOTE KEYPAD MODE”: ENT key)
	Invalid in “COPY MODE” (In “REMOTE KEYPAD MODE”: EASY key)		

3. Connection and start-up

Connect Remote Keypad with the inverter according to the procedure stated below.

(1) Set Communication Mode Switch (refer to page.7) on the reverse side of Remote Keypad. The position varies for the inverter series.

RS485: The inverter with RS485 (2-wire type) port (ex: VF-AS1, VF-nC3, VF-S15 etc.)

LOGIC: The inverter with Common Serial Port (ex: VF-S11, VF-nC1, VF-S9, VF-A7, VF-P7).

(2) Set communication baud rate (the inverter parameter “*F B 0 0*”) to 9600, 19200 or 38400bps (programmed by default setting at the factory).

(3) Turn off the input power to the inverter, wait at least 15 minutes, and insure that the charge lamp on the inverter is no longer lit.

(4) Connect an inverter-unit connection cable (optional) between the communication connector of Remote Keypad and that of the inverter. At this time, be careful not to apply excessive force to the connectors.

(See the instruction manual of the inverter for connection to the communication port of the inverter.)

(5) After wiring, fix the wires on the surface of the wall in the panel board and so on.

(6) Turn on the inverter, and Remote Keypad starts-up automatically showing a lit panel in the display window.

(7) Using in “COPY MODE”, check that the “COPY MODE” lamp is lit.

(8) In order to change from “REMOTE KEYPAD MODE” to the “COPY MODE”, turn off the power of inverter and insure that the Remote Keypad is also turned off. Then, turn on the power of the inverter (Remote Keypad) while holding down the [ENT] key of Remote Keypad.

N.B.: When disconnecting Remote Keypad from the inverter, follow step (3) of the above procedure.

4. Functions in detail

Remote Keypad can be used as remote operation panel (“REMOTE KEYPAD MODE”) or parameter back-up device (“COPY MODE”). When the “COPY MODE” lamp is lit when turning power on, Remote Keypad operates in “COPY MODE”, otherwise in “REMOTE KEYPAD MODE”.

4.1. Procedure to switch the operation mode

According to the procedure described in “3. Connection and start-up”, turn on the power of Remote Keypad while holding down the [ENT] key of Remote Keypad. Operation mode changes.

4.2. “REMOTE KEYPAD MODE”

In “REMOTE KEYPAD MODE”, operation is the same as operation on the panel of the inverter. For details, see instruction manual of the inverter. Data entered through Remote Keypad takes priority over data entered through the inverter’s control panel. However, if Remote Keypad is deactivated by an unexpected event such as an abnormality, the inverter’s input keys remain functional.

4.3. “COPY MODE”

In “COPY MODE”, storing and loading the parameters are permitted. Editing the parameters is not permitted.

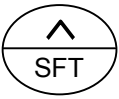
Key	LED indication	Key operation and description
_____	“CHC” → “In It” → “COPY”	When “COPY MODE” is initiated, “CHC” is shown in the display window. This is followed by “In It” to indicate that the power supply is being initialized. Finally, when ready to use the display shows “COPY”.
	“COPY” → “COMP” → “PrOt” → “CLr” → “F - ” → “COPY”	< Selecting a desired function > Select the function with the [SFT] key. Each time the [SFT] key is pressed, indication on the display changes from “COPY” (copying function) to “COMP” (comparing function), to “PrOt” (memory protecting function), to “CLr” (memory initializing function), to “F - ” (Remote Keypad parameter editing function), and finally back to “COPY” again in this order.

4.3.1. Copying function “COPY”

The data stored in a memory can be copied to another memory selected from among four memories (the inverter's memory and Remote Keypad memories A, B, and C). Remote Keypad can not be used to copy parameters from one inverter to another inverter of a different series.

N.B.: To copy the data to the inverter's memory, do it when the inverter has stopped. If you copy the data to the inverter while the inverter is running, some of the parameters fail to be copied.

Operating procedure

Key	LED indication	Key operation and description
————	“COPY”	< Selecting a desired function > Select “COPY” (copying function) with the [SFT] key. (“COPY” automatically appears just after starting up.)
○ ENT	“COPY” → “In”	< Entering the selected function > After selecting “COPY” with the [SFT] key, press the [ENT] key. “In” (selecting inverter memory) appears in the display window.
○ \wedge SFT	“In” → “A” → “b” → “C” → “In”	< Selecting a memory to copy its data > Select a memory to copy its data with the [SFT] key. Each time the [SFT] key is pressed, the display changes as follow: “In” (selecting inverter memory) “A” (selecting memory A) “b” (Selecting memory B) “C” (selecting memory C) and to “In” again in this order.
○ ENT	“In” → “In-A”	< Entering the memory to copy its data > After selecting the memory to copy from, press the [ENT] key. Example: select “In”, press [ENT] key, and “In-A” appears in the display window.
○ \wedge SFT	“In-A” → “In-b” → “In-C” → “In-A” (“A-In” → “A-b” → “A-C” → “A-In”)	< Selecting a memory to transcribe copied data > Select a memory to transcribe copied data with the [SFT] key. Each time the [SFT] key is pressed, the display changes as follow “In-A” (copying data from inverter memory to memory A) “In-b” (copying data from inverter memory to memory B) “In-C” (copying data from inverter memory to memory C) and to “In-A” again in this order. If the memory A, B, or C is selected as to copy data from, the display changes accordingly (example shown in parentheses for memory A).
○ ENT	“In-A” → “F ___”	< Executing copy function > After selecting the memory to copy to (Example: “In-A” select memory A as to copy to), press the [ENT] key, and start copying. Then the display shows “F ___”. This is the parameter title of the parameter being copied now. If Remote Keypad is unable to copy the selected parameter, the display shows the parameter title flashing in the display window. To continue copying, press [ENT] key.
————	“COMP” → “End” → “___” (4 digits)	< Completion of copying function > After completing the copy operation, “COMP” begins to flash to indicate that Remote Keypad is comparing two sets of parameters. (Refer to “comparing function” in section 4.3.3). When the comparison is end, it displays CRC code “___” (4 digits in hexadecimal number) of memory data for error detection after displaying “End”. If the parameters are different, the comparison interrupts and the parameter title number flashes on display. To continue comparison for next parameter, press [ENT] key. When the comparison is end, the CRC codes of original and copied memory data for error detection flash alternately after displaying “End”. The CRC code “___” (4 digits in hexadecimal number) changes depending on the data condition.
○ ENT	“___” → “COPY”	< Ending copying > Press the [ENT] key and the indication in the display window returns to “COPY”.

- If the [ESC] key is pressed, Remote Keypad returns to previous status (except when executing).
- When the memory protection function is actuated, Remote Keypad inhibits copying data with “PrOt” appearing in the display window.
- If there is no data in memory A of Remote Keypad upon selection as data to copy from, the display shows “Err.A” which means copying data is impossible. (When the memory B or C is selected in the same condition, “Err.b” or “Err.C” appears in the display window)
- In “A-In”, “b-In” and “C-In”, when the data of the inverter increases by the upgrade, the data not included in memory A, B, and C is not changed.

4.3.2. Simple copying function

The data stored in the memory A, B or C of Remote Keypad can be copied to the inverter's memory with simple operation of two keys to select one of the memories A, B and C. Use this function to set the same parameters to more than two inverters. Remote Keypad can not copy parameters to from one inverter to another inverter of a different series. What differs from the "Copying function" in Section 4.3.1 is the key operation and the contents of parameters to be copied are the same for both functions. It is impossible to copy data from the inverter's memory to a memory of Remote Keypad in this function.

N.B.: To copy data to the inverter's memory, do it when the inverter has stopped. If you copy data to the inverter while the inverter is running, some of the parameters may fail to be copied.

Operating procedure

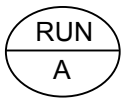
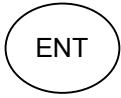
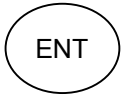
Key	LED indication	Key operation and description
	"COPY" → "A - In"	<p>< Selecting and entering a memory to copy its data > Press the key corresponding to the memory selected to copy data from, while "COPY" is being displayed. [A] key: To copy data from memory A to the inverter's memory. [B] key: To copy data from memory B to the inverter's memory. [C] key: To copy data from memory C to the inverter's memory. When memory A is selected to copy its data to the inverter's memory for example, the display changes from "COPY" to "A - In" (copying data from memory A to inverter's memory).</p>
	"A - In" → "F _ _ _"	<p>< Executing copy function > After selecting the memory to copy from (to inverter, Example: select "A - In"), press the [ENT] key, and start copying. Then the display shows "F _ _ _". This is the parameter title of the parameter being copied now. If Remote Keypad is unable to copy the selected parameter, the display shows the parameter title flashing in the display window. To continue copying, press [ENT] key.</p>
_____	"COPY" → "End" → " _ _ _ _ " (4 digits)	<p>< Completion of copying function > After completing the copy operation, "COPY" begins to flash to indicate that Remote Keypad is comparing two sets of parameters. (Refer to "comparing function" in section 4.3.3). When the comparison is end, it displays CRC code " _ _ _ _ " (4 digits in hexadecimal number) of memory data for error detection after displaying "End". If the parameters are different, the comparison interrupts and the parameter title number flashes on display. To continue comparison for next parameter, press [ENT] key. When the comparison is end, the CRC codes of original and copied memory data for error detection flash alternately after displaying "End". The CRC code " _ _ _ _ " (4 digits in hexadecimal number) changes depending on the data condition.</p>
	" _ _ _ _ " → "COPY"	<p>< Ending copying > Press the [ENT] key and the indication in the display window returns to "COPY".</p>

- If the [ESC] key is pressed, Remote Keypad returns to previous status (except when executing).
- When the memory protection function is actuated, Remote Keypad inhibits copying data with "P r O t" appearing in the display window.
- If there is no data in memory A of Remote Keypad upon selection as data to copy from, the display shows "E r r . A" which means copying data is impossible. (When the memory B or C is selected in the same condition, "E r r . b" or "E r r . c" appears in the display window.)
- In "A - In", "b - In" and "c - In", when the data of the inverter increases by the upgrade, the data not included in memory A, B, and C is not changed.

The same operation as above can also be used to copy data from memory B or memory C of Remote Keypad to the inverter.







Since the [A], [B], and [C] keys are provided to be used exclusively for the simple copying function, those keys cannot be used for other functions.

4.3.3. Comparing function “COMP”

This function enables the operator to compare data stored in two memories selected from among four memories (the inverter’s memory and Remote Keypad memories A, B, and C) as well as to search for parameters that differ from each other.

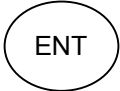
The comparing function cannot be used for editing parameters because it is provided only for searching parameters that differ from each other. Use the “REMOTE KEYPAD MODE” function described in section 4.2 to edit parameters.

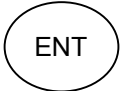
Operating procedure

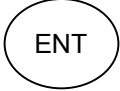
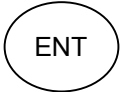
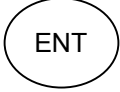
Key	LED indication	Key operation and description
	“COPY” → “COMP”	< Selecting a desired function > Select “COMP” (comparing function) with the [SFT] key.
	“COMP” → “In”	< Entering the selected function > After selecting “COMP” with the [SFT] key, press the [ENT] key and “In” (selecting inverter memory) appears in the display window.
	“In” → “A” → “b” → “C” → “In”	< Selecting a memory > Each time the [SFT] key is pressed, the display changes as follow “In” (selecting inverter memory) “A” (selecting memory A) “b” (selecting memory B) “C” (selecting memory C) and to “In” again in this order.
	“In” → “In = A”	< Entering the memory > After selecting the memory, press the [ENT] key. For example, select “In”, press [ENT] key, and “In = A” appears in the display window.
	“In = A” → “In = b” → “In = C” → “In = A” (“A = In” → “A = b” → “A = C” → “A = In”)	< Selecting a memory to compare its data with that of the previously selected memory > Each time the [SFT] key is pressed, the display changes as follow “In = A”: comparing data between inverter memory and memory A “In = b”: comparing data between inverter memory and memory B “In = C”: comparing data between inverter memory and memory C and to “In = A” again in this order. If for example memory A is selected instead of “In” different indication appears as shown in parentheses.
	“In = A” → (flashing)	< Entering the selected memory to compare its data with the original > After selecting “In = A” (selecting memory A to compare its data with that of the inverter’s memory for example), press the [ENT] key, and Remote Keypad starts comparing the data of the two memories with each other.
	“F000” → “F999”	< Executing data comparison (searching different parameters) > Remote Keypad compares parameters consecutively while displaying the parameter title. When Remote Keypad finds two parameters that differ from each other, it discontinues comparing operation and shows the parameter title flashing in the display window. Press the [ENT] again to continue the comparing operation.
_____	“COMP” → “End” → “_____” (4 digits)	< Comparing is complete > After displaying “End”, the CRC code “_____” (4 digits in hexadecimal number) of memory data for error detection is displayed. If the parameters are different, the CRC codes of original and compared memory data for error detection flash alternately after displaying “End”. The CRC code “_____” (4 digits in hexadecimal number) changes depending on the data condition.
	“_____” → “COMP”	< Ending comparing > Press the [ENT] key and the indication in the display window returns to “COMP”.

- If the [ESC] key is pressed, Remote Keypad returns to previous status (except when executing).

4.3.4. Memory protection function “PrOt”

The memory protection function protects the selected memory from being overwritten.





When this function is initiated copying data to the memory is prohibited. Reading the memory data is permitted.

When all the memories are initialized by memory initialization function (CLr), the LED indications are as follows:

“In”, “A”, “b”, “C” = “OFF”, “SUP” = “On”

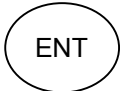
This is also the default setting at the time of shipment.

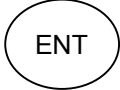
Operating procedure

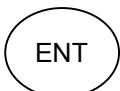
Key	LED indication	Key operation and description
	“COPY” → “COnP” → “PrOt”	< Selecting a desired function > Select “PrOt” (memory protection function) with the [SFT] key.
	“PrOt” → “In”	< Entering the selected function > After selecting “PrOt” with the [SFT] key, press the [ENT] key and “In” (selecting inverter memory) appears in the display window.
	“In” → “A” → “b” → “C” → “SUP” → “In”	< Selecting a memory to protect its data > Each time the [SFT] key is pressed, the display changes as follow “In” selecting inverter memory “A” selecting memory A “b” selecting memory B “C” selecting memory C “SUP” special parameter selection (*1) and to “In” again in this order.
	“In” → “OFF” “In” → “On”	< Entering the memory to protect its data > After selecting “In” (selecting inverter memory, by way of example) with the [SFT] key, press the [ENT] key and the display shows the present memory protection status. (When “On” appears on the display, the selected memory is protected. When “OFF” appears on the display, the selected memory is not protected.)
	“OFF” → “On” → “OFF”	< Protecting the selected memory > Each time the [SFT] key is pressed, the indication in the display changes “On” protecting the selected memory (write prohibited) “OFF” canceling protection of the selected memory (write permitted) alternately.
	“On” → “PrOt”	< Executing protection of the selected memory > After selecting “On” (protecting the selected memory, by way of example) with the [SFT] key, press the [ENT] key. Remote Keypad starts protecting the selected memory (canceling the protection in case of “OFF”) and the indication in the display window returns to “PrOt”.

- If the [ESC] key is pressed, Remote Keypad returns to previous status (except when executing).

(*1) The Protecting operation of “SUP” is different from that provided for other memories and is shown below.

With the same inverter types
(capacity, voltage class)

SUP	Standard parameters	Special parameters
On	✓	—
OFF	✓	✓

With different inverter types
(capacity, voltage class)

SUP	Standard parameters	Special parameters
On	✓	—
OFF (*2)	—	—





“✓”: Protection disabled (write permitted), “—”: Write protected (write prohibited)

(*2) In this case, copying operation of parameters from one inverter to another inverter of a different capacity or a different voltage class.

4.3.5. Memory initializing function “*CLr*”

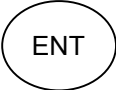
A selected one of the memories either memory A, B, C of Remote Keypad is enable to be initialized with this function. In addition, all memories including system memory of Remote Keypad is also enable to be initialized.

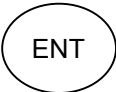
Operating procedure

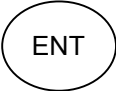
Key	LED indication	Key operation and description
	“ <i>COPY</i> ” → “ <i>CONF</i> ” → “ <i>PrOt</i> ” → “ <i>CLr</i> ”	< Selecting a desired function > Select “ <i>CLr</i> ” (memory initializing function) with the [SFT] key.
	“ <i>CLr</i> ” → “ <i>A</i> ”	< Entering the selected function > After selecting “ <i>CLr</i> ” with the [SFT] key, press the [ENT] key and “ <i>A</i> ” (selecting memory A) appears in the display window.
	“ <i>A</i> ” → “ <i>b</i> ” → “ <i>C</i> ” → “ <i>555</i> ” → “ <i>A</i> ”	< Selecting a memory to initialize > Each time the [SFT] key is pressed, the display changes as follow “ <i>A</i> ” selecting memory A “ <i>b</i> ” selecting memory B “ <i>C</i> ” selecting memory C “ <i>555</i> ” selecting all memories (reprogram to default setting) and to “ <i>A</i> ” again in this order.
	“ <i>A</i> ” → “ <i>OFF</i> ”	< Entering the memory to initialize > After selecting a memory for initialization (selecting memory A, by way of example) with the [SFT] key, press the [ENT] key and “ <i>OFF</i> ” appears in the display window.
	“ <i>OFF</i> ” → “ <i>On</i> ” → “ <i>OFF</i> ”	< Initializing the selected memory > Each time the [SFT] key is pressed, the display changes “ <i>On</i> ”(to initialize selected memory) “ <i>OFF</i> ” (not to initialize the selected memory). alternately.
	“ <i>On</i> ” → “ <i>Init</i> ” → “ <i>CLr</i> ”	< Executing initialization of the selected memory > After selecting “ <i>On</i> ” with the [SFT] key, press the [ENT] key and Remote Keypad starts initializing the selected memory with the indication “ <i>Init</i> ” appearing in the display window. When the initialization of the selected memory is complete, the indication in the display window returns to “ <i>CLr</i> ”.

- If the [ESC] key is pressed, Remote Keypad returns to previous status (except when executing).
- When the memory protection function is actuated, Remote Keypad prohibits the initialization of memory with “*PrOt*” appearing in the display window.

4.3.6. Remote Keypad parameter editing function

This function allows the user to edit the parameters of Remote Keypad.





Remote Keypad parameter list

Title	Function	Description
<i>F - 0 1</i>	Software version displaying	Display shows the software version of Remote Keypad.
<i>F - 0 2</i>	Automatic comparing function	Automatic comparing function can be turned on or off. <i>0</i> : Not executing comparison after copying <i>1</i> : Executing comparison after copying (default)

Warning

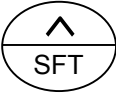
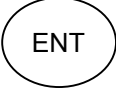
It is recommended to set the automatic comparing function "*F - 0 2*" to "*1*" (default). When "*0*" is selected, programming errors (caused by environmental circumstances, peripheral devices, etc.) will not be automatically detected. This could result in an accident, if the inverter is operating with the wrong parameters.

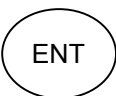
Operating procedure

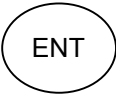
Key	LED indication	Key operation and description
	"COPY" → "CONF" → "PrOt" → "CLR" → "F - "	< Selecting a desired function > Select "F - " (Remote Keypad parameter editing function) with the [SFT] key.
	"F - " → "F - 0 1"	< Entering the selected function > After selecting "F - " with the [SFT] key, press the [ENT] key and "F - 0 1" appears in the display window.
	"F - 0 1" → "F - 0 2"	< Selecting a parameter title to edit or display > Each time the [SFT] key is pressed, the display changes <i>F - 0 1</i> Software version displaying <i>F - 0 2</i> Automatic comparing function alternately.
	"F - 0 2" → " 1" ("F - 0 1" → " 100")	< Entering a parameter title to edit or display > If "F - 0 2" is selected with the [SFT] key and the [ENT] key is pressed, the current value (" 1": Executing comparison after copying by way of example) appears in the display window. If "F - 0 1" is selected as parameter to display, the indication of Remote Keypad software version appears as shown in parentheses.
	" 1" → " 0" → ...	< Changing a value of selected parameter > Each time the [SFT] key is pressed, indication in the display window alternately changes between " 1" and " 0". However the software version does not change.
	" 0" → " 0" (flashing) → "F - 0 2"	< Executing edit parameter > After selecting " 0" (Not executing comparison after copying) with the [SFT] key, press the [ENT] key and Remote Keypad starts writing the parameter value to its memory, and flashes the value in the display window. When the writing is complete, indication of the display returns to the parameter title ("F - 0 2").

- If the [ESC] key is pressed, Remote Keypad returns to previous status (except when executing).
- The memory protection function (write protection) can not protect Remote Keypad parameter.
- The memory initialization function initializes Remote Keypad parameter when "5 5 5 (selecting all memories)" is selected.

5. Before making a service call

If a problem arises, please see the following trouble-shooting tables. If the problem can not be solved, please contact a Toshiba distributor.

5.1. Error message

Malfunction indications: Indicated by flashing LED display

Error Code	Problem and Solutions
<i>r A n E</i>	RAM built in Remote Keypad is abnormal. If the same indication appears after resetting Remote Keypad, it needs to be repaired.
<i>r O n E</i>	ROM built in Remote Keypad is abnormal. If the same indication appears after resetting Remote Keypad, it needs to be repaired.
<i>C P U E</i>	Micro controller unit of Remote Keypad is abnormal. If the same indication appears after resetting Remote Keypad, it needs to be repaired.
<i>b t n E</i>	Is any key kept being pressed (for about 10 seconds)? This indication will automatically cancel itself. If the display shows the indication after turning off all keys, it needs to be repaired. N.B.: In "REMOTE KEYPAD MODE" this is only alarm displaying. The operation keys are also effective while the display is showing this alarm message.
<i>E E P E</i>	EEPROM built in Remote Keypad is abnormal. If the same indication appears after writing data again, it needs to be repaired.
<i>C O n E</i>	Abnormal communication Check the connection of the inverter's serial communication cable, Communication Mode Switch on the reverse of Remote Keypad, the baud rate (inverter's parameter "F B 0 0") and transmission delay time (inverter's parameter "F B 0 5" is recommended to be set to 0). This indication will automatically cancel itself. If abnormality is not found after checking and resetting Remote Keypad, it needs to be repaired.

5.2. Procedure to reset Remote Keypad

There are two methods to reset the micro controller unit inside Remote Keypad.

- Method 1:

Reset the power source of Remote Keypad.

- Method 2:

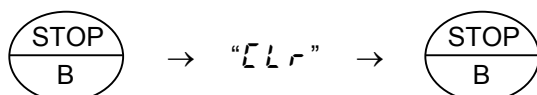

If [STOP] key is pressed while an error message is displayed, "E L r" flashes for one second. If you press the [STOP] key again when "E L r" flashes, Remote Keypad will be reset.

5.3. Warning indications

Warning indications: Indicated by flashing LED display.

Warning Code	Problem and Solutions
<i>P r O t</i>	The target memory to copy data or to initialize is write protected. Copying any data to the memory or initializing the memory cannot be executed. Press the [ESC] key to cancel.
<i>d E v E</i>	The type of device is different (different in series or voltage class or capacity of inverter). Press the [ENT] key to copy between two inverters of different capacity or voltage class. Press the [ESC] key to cancel copying. If “ <i>S U P</i> ” (system area parameters) protection has been disabled by setting “ <i>P r O t</i> ”(memory protection) to “ <i>O F F</i> ”, the copying cannot be executed even if the [ENT] key is pressed. Copying to the inverter of a different series is impossible. After copying between two inverters with different capacities, the type information parameters depending on the inverter capacity or voltage class should be initialized. See the inverter instruction manual on how to initialize them.
<i>E r r . A</i> <i>E r r . b</i> <i>E r r . C</i>	Indicated memory is not found or has been corrupted. This indication appears when memory A, B, or C is selected to copy data from, to compare data to, or to protect data, but no data can be found in the selected memory (including the case when power was turned off during the previous copying operation), or a CRC code error occurred in the selected memory. Press the [ESC] key to cancel. In this case the data has to be rewritten.
<i>F _ _ _</i> (title number)	Indicates the title number of the parameter that was found to be different while using comparison function, or that can not be written while using the copying function. Press the [ENT] key to continue, the [ESC] key to cancel. When Remote Keypad did not find any data in one memory, it flashes “%” in case the data is missing in the memory that was selected first, or “Hz” if it is missing in the memory that was selected second. This may happen parameter data may be missing when the software versions of two inverters are different. N.B.: Parameter titles are written to the inverter memory in consecutive order. When Remote Keypad indicates missing or mismatched data by flashing a parameter title number on the display, all prior parameter titles will have been written to the inverter already.
<i>_ _ _ _</i> (4 digits CRC code)	When CRC code difference of parameters was found as a result of comparison, two alternating CRC code indicates appear in the display window. In this case, there is a different parameter. If the title of different parameter is not found, execute comparison again after setting “ <i>S U P</i> ” in memory protection function to “ <i>O F F</i> ”.

5.4. Other problems

Phenomenon	Problem and Solutions
Display is extinguished.	Check the connection of the serial communication cable. Check the kind of the serial communication cable. Check that the power of the inverter is turned on.
% lamp and Hz lamp are not lit	When Remote Keypad is connected to the following inverters, % lamp and Hz lamp is not lit. VF-S11, VF-nC1, VF-S9, VF-A7, VF-P7, etc.
Key is not effective	It needs to be repaired. [EASY] key is effective only for the inverter with [EASY] key.
Parameters can not be written	Some parameters can not be written while the inverter is running. See the instruction manual of the inverter. Copying the parameters between inverters of different series is impossible.

6. Outline drawing

■ Following is the outline drawing of Remote Keypad

(Unit: mm)

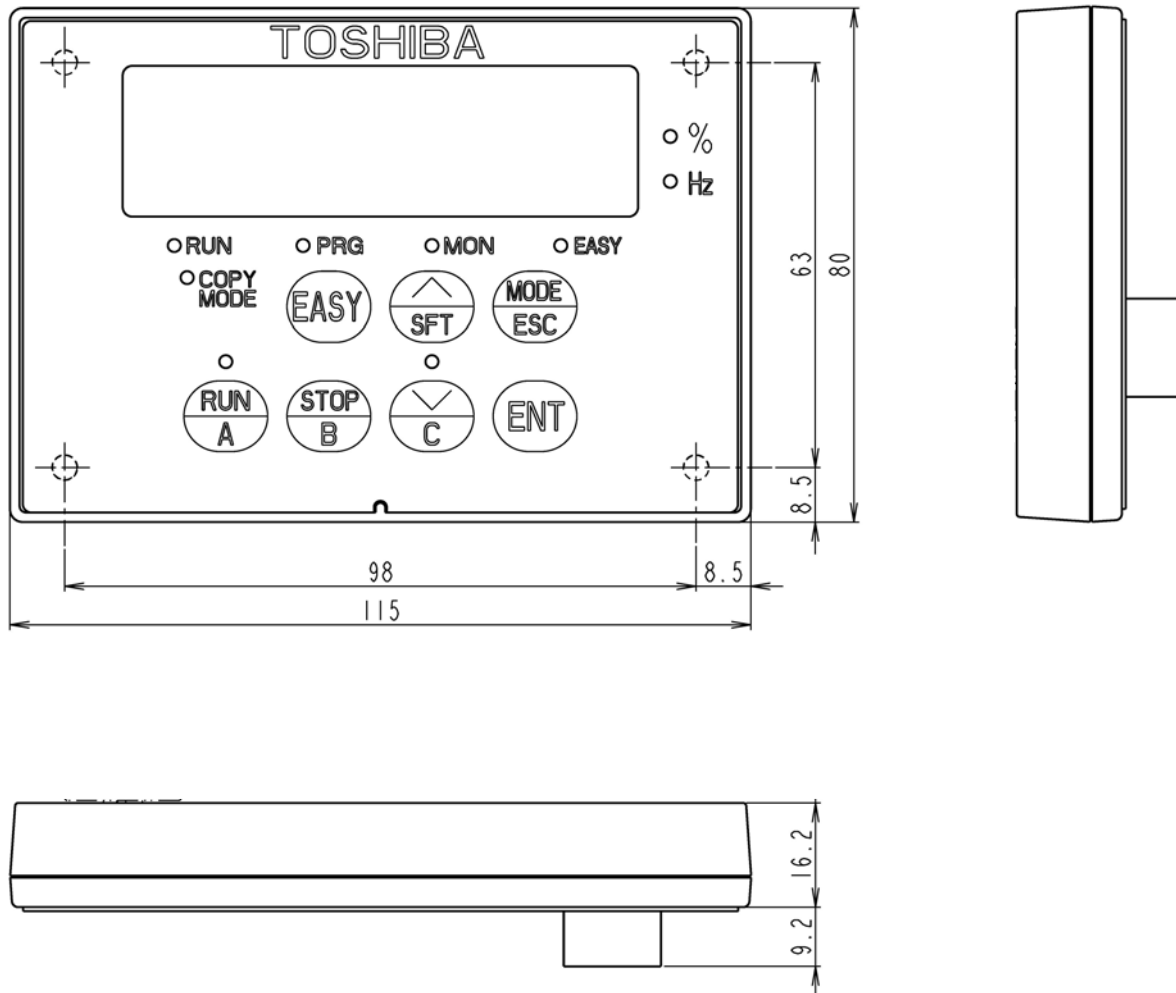

■ Mounting

Mount Remote Keypad on the front of the panel board as illustrated below.

On the front of the panel board, cut the area shown below for mounting Remote Keypad. Then, fix Remote Keypad on the panel board with the mounting screws (M3 x 12) supplied as accessories. (M3 screw tightening torque: 0.6 N·m)

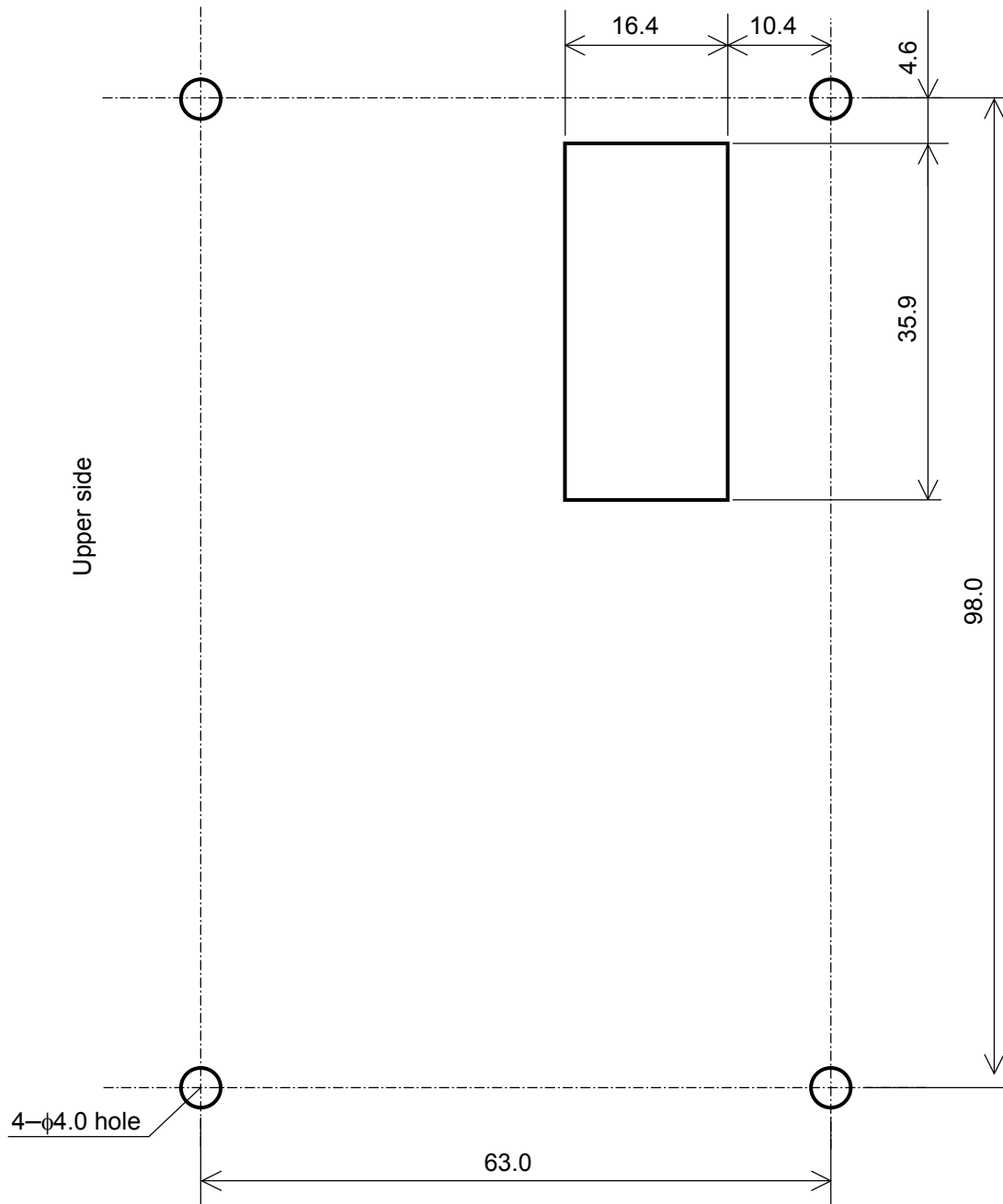

Unit: mm
(The front view of the panel board)

7. Specifications

Item	Specifications
Part number	RKP002Z
Applicable model	Model with either an RS485 (2-wire type) connector or a common serial connector (optional) with a baud rate of 9600, 19200 or 38400bps.
Communication	Automatic search: Baud rate: 9600, 19200, 38400bps Parity: even, odd, none Communication method: RS485 (2-wire type) or Common Serial Communication, switched by Communication Mode Switch
Service environment	Indoor operation at an altitude of 1,000m or less and free from direct sunlight, potentially corrosive or explosive gases, steam, dust particles, dust/dirt, and machining fluids including grinding liquid and coolant
Ambient temperature	-10 to +50°C
Storage temperature	-25 to +65°C
Relative humidity	20 to 93% (free from condensation and vapor)
Vibration	5.9m/s ² (0.6G) or less (10 to 55Hz)
Cooling method	self-cooling

8. Warranty

Any part of the unit that is proved to be defective will be repaired free of charge under the following conditions:

1. This product will be repaired free of charge, if problem/fault occurs under normal handling within one year of delivery and is caused obviously by a design or manufacturing defect.
2. The warranty applies only to the delivered unit.
3. For the following kinds of failure or damage, the repair cost shall be borne by the customer even within the warranty period.
 - i) Failure or damage caused by improper or incorrect use or handling, or unauthorized repair or modification of the inverter.
 - ii) Failure or damage caused by the unit falling or an accident during transportation after the purchase.
 - iii) Failure or damage caused by fire, salty water or wind, corrosive gas, earthquake, storm or flood, lightning, abnormal voltage supply, or other natural disasters.
 - iv) Damage due to the use of Remote Keypad for non-intended purposes.
4. If an additional warranty is provided then those conditions will also apply.